

CLEAN SOIL

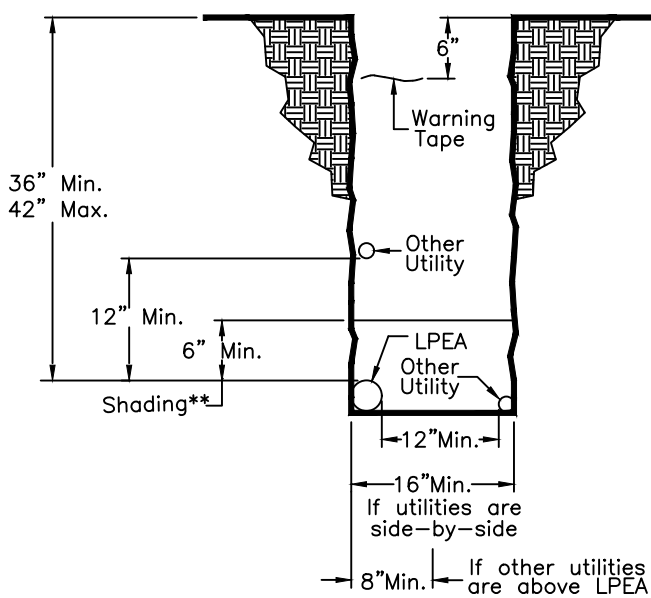

ROCKY SOIL

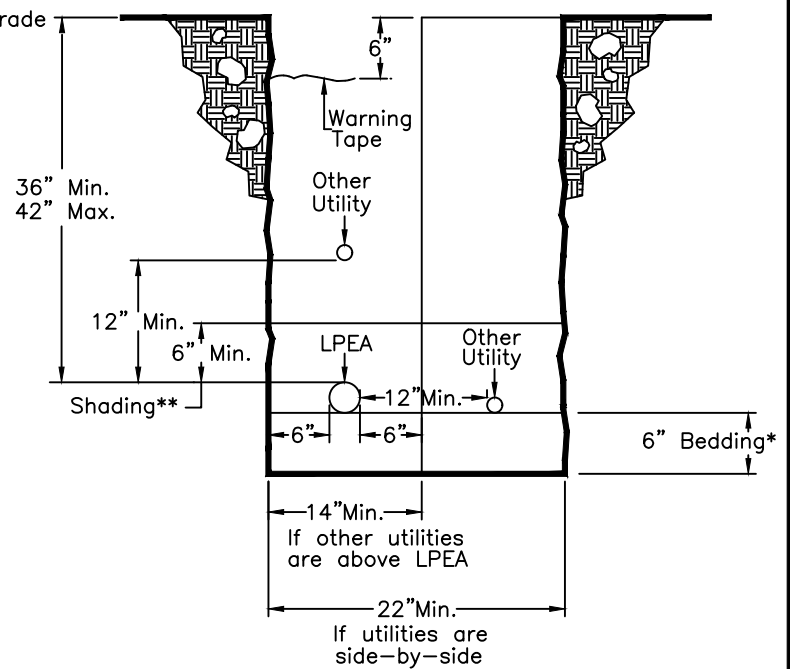

SOLID ROCK

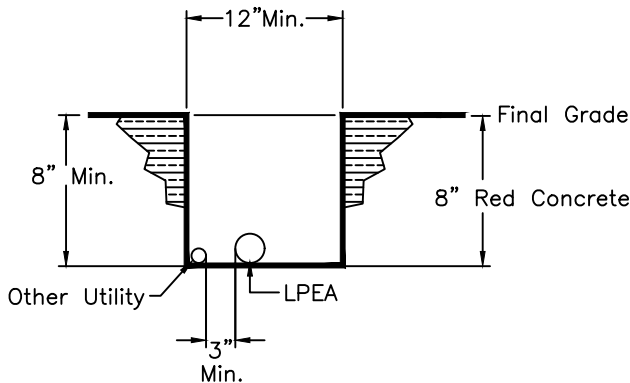

IRRIGATION DITCH

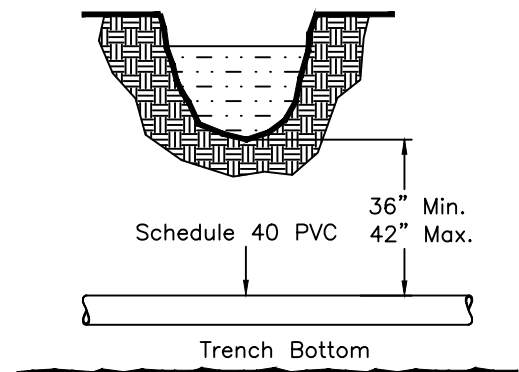

NOTES:

- 3" GREY SCHEDULE 40 PVC SLEEVE REQUIRED ON ALL SINGLE PHASE ROAD CUTS.
- 6" GREY SCHEDULE 40 PVC SLEEVE REQUIRED ON ALL THREE PHASE ROAD CUTS.
- 6" HDPE PIPE WILL BE UTILIZED FOR ALL BORES

WARNING TAPE SUPPLIED BY LPEA; INSTALLED BY CUSTOMER.

- * BEDDING (ROCK FREE DIRT OR SAND) TO BE SUPPLIED AND INSTALLED BY CUSTOMER.
- ** SHADING (ROCK FREE DIRT OR SAND) TO BE SUPPLIED BY CUSTOMER; INSTALLED BY LPEA CREW. SHADING MUST BE SUPPLIED IN 20' INCREMENTS ALONG THE DITCH.

NO.	DATE	REVISIONS	APP'D

LPEA

La Plata Electric Association, Inc.

A Touchstone Energy Cooperative 

PO Box 2750
Durango CO 81302-2750
COLORADO 32 LaPLATA

DRAWN
JDD
CHECKED
APPROVED
DATE
06/26/08
FILE NAME
SPEC1.dwg

UG TRENCH AND BEDDING SPECIFICATIONS PRIMARY

SCALE
NONE

DRAWING NUMBER
SPEC 1

CLEAN SOIL

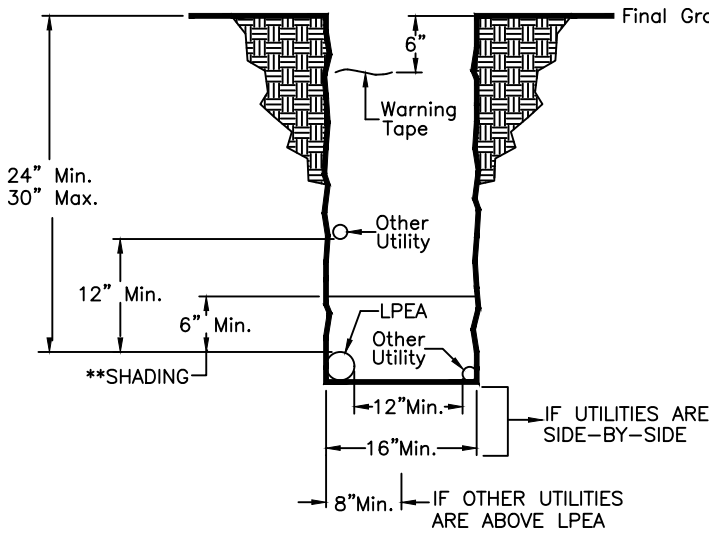

ROCKY SOIL

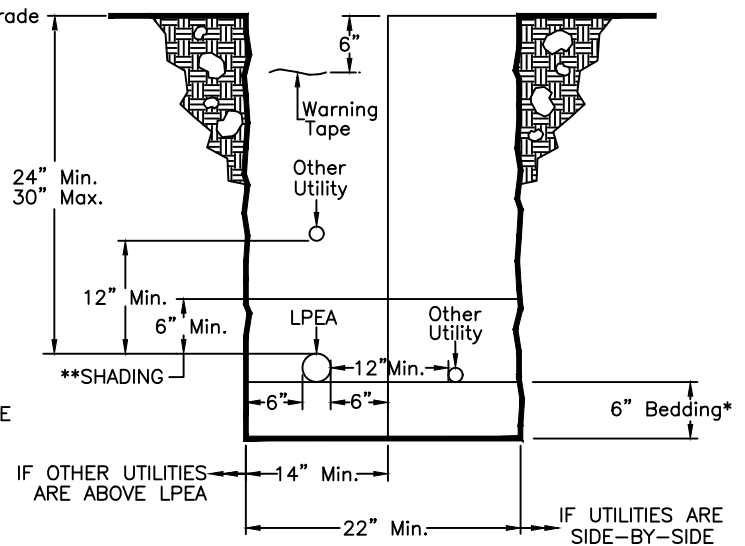

SOLID ROCK

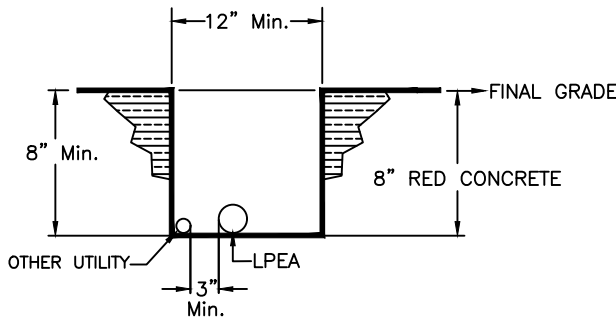

IRRIGATION DITCH

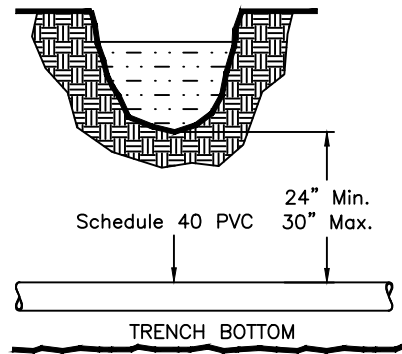

NOTES:

3" GREY SCHEDULE 40 PVC SLEEVE REQUIRED ON ALL SINGLE PHASE ROAD CUTS.

3" HDPE PIPE WILL BE UTILIZED FOR ALL SINGLE PHASE BORES

6" GREY SCHEDULE 40 PVC SLEEVE REQUIRED ON ALL THREE PHASE ROAD CUTS.

6" HDPE PIPE WILL BE UTILIZED FOR ALL THREE PHASE BORES

FLOW FILL NOT ACCEPTED.

WARNING TAPE SUPPLIED BY LPEA; INSTALLED BY CUSTOMER.



SERVICES 400 AMP OR GREATER REQUIRE CONSULTATION WITH A STAKING ENGINEER REGARDING SECONDARY REQUIREMENTS.

SERVICES GREATER THAN 800 AMP WILL REQUIRE PARALLEL RUNS OF CONDUIT OF ADEQUATE SIZE FOR THE REQUIRED CONDUCTOR. CUSTOMER MUST CONSULT WITH STAKING ENGINEER.

* BEDDING (ROCK FREE DIRT OR SAND) TO BE SUPPLIED AND INSTALLED BY CUSTOMER.

** SHADING (ROCK FREE DIRT OR SAND) TO BE SUPPLIED BY CUSTOMER; INSTALLED BY LPEA CREW.

** SHADING MUST BE SUPPLIED IN 20' INCREMENTS ALONG THE DITCH.

NO.	DATE	REVISIONS	APP'D	 <p>La Plata Electric Association, Inc. A Touchstone Energy Cooperative </p> <p>PO Box 2750 Durango CO 81302-2750 COLORADO 32 LaPLATA</p>	DRAWN JDD	UG TRENCH AND BEDDING SPECIFICATIONS SECONDARY	
1	4/27/21	Removed suggested secondary wire type table	MAF		CHECKED		
2	4/27/21	Corrected HDPE sizes on bores	MAF		APPROVED		
3	4/27/21	Added required engineer consultation for services of 400 amps or greater.	MAF		DATE 06/26/08	SCALE NONE	DRAWING NUMBER SPEC 2
					FILE NAME SPEC2.dwg		

8" - 17" TRENCH DEPTH

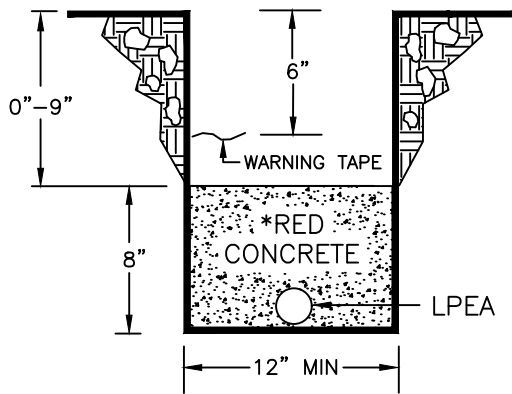

18" - 23" TRENCH DEPTH

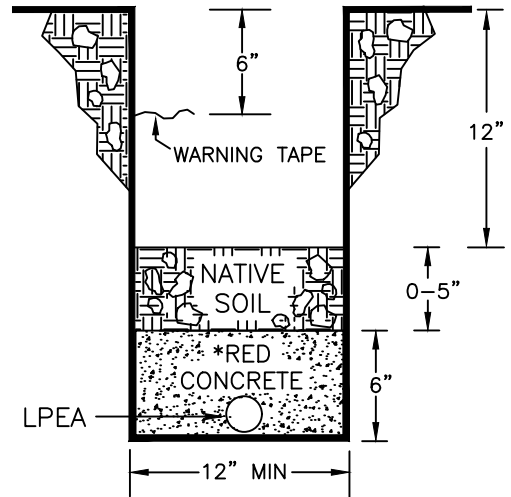

30"-35" TRENCH DEPTH

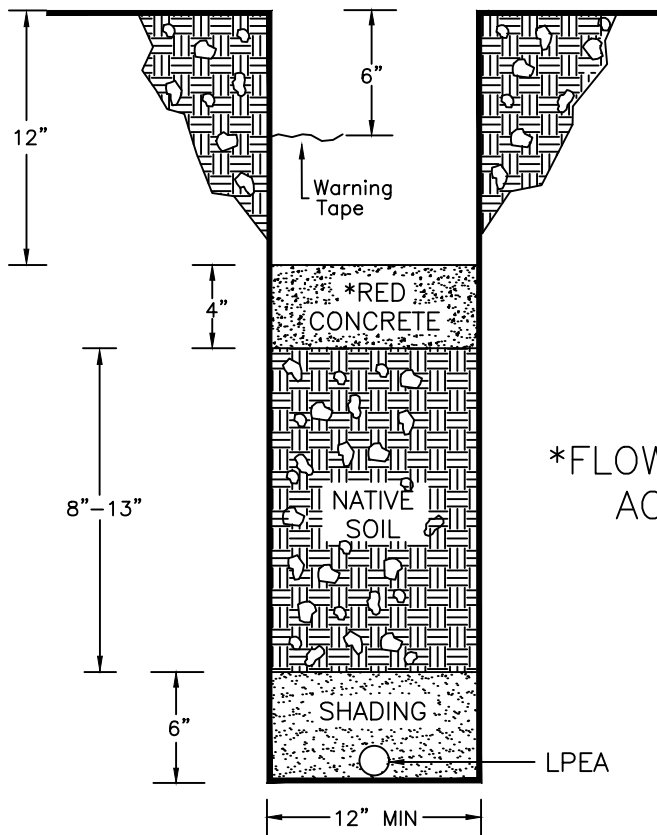

24"-29" TRENCH DEPTH

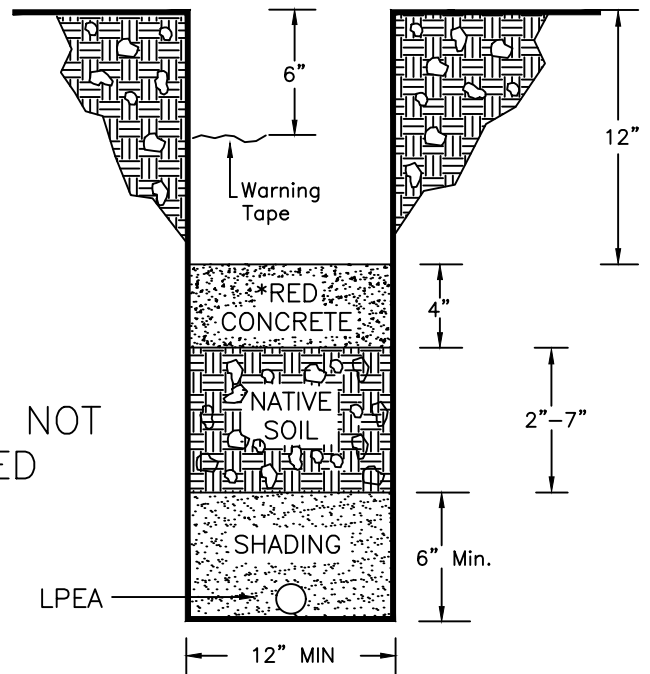

*FLOW FILL NOT ACCEPTED

NO.	DATE	REVISIONS	APP'D

LPEA

La Plata Electric Association, Inc.

A Touchstone Energy Cooperative

PO Box 2750
Durango CO 81302-2750
COLORADO 32 LaPLATA

DRAWN MF
CHECKED
APPROVED
DATE 06/30/08
FILE NAME SPEC3.dwg

UG TRENCH
SHALLOW DEPTH
PRIMARY / SECONDARY

SCALE
NONE

DRAWING NUMBER
SPEC 3